

180 IG series

mmx180mmx65mm



General Specifications

- Motor : Singal phase induction capacitor motor
- Frame & Impller : Al Die-casting & PBT plsatic
- Storage temperature : -40°C to +75°C
- Operating temperature : -10°C to +60°C

Major Characteristic Parameters

Model	Bearing System	Rated Voltage	Freq.	Power Input	Rated Speed	Maximum Air Flow	Maximum Static Pressure	Sound Level	Weight		
Part NO.	B / S	V	Hz	W	RPM	m ³ /min	CFM	mm-H ₂ O	In-H ₂ O	dBA	Kg
IGE18065_1H	B / S	80-125	50/60	60/75	2650/3000	10.8/13.0	380/450	20/26	0.79/1.02	60	1.80
IGE18065_2H	B / S	150-240	50/60	60/75	2650/3000	10.8/13.0	380/450	20/26	0.79/1.02	60	1.80

*Bearing system B: Two Ball Bearing F: Fluid Bearing S: Sleeve Bearing

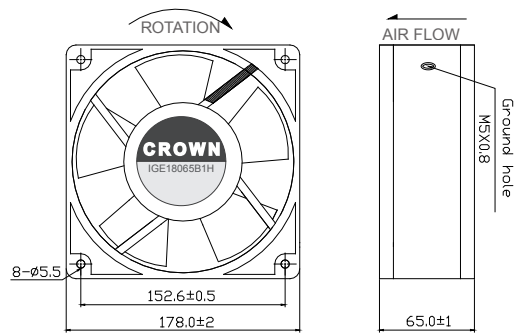
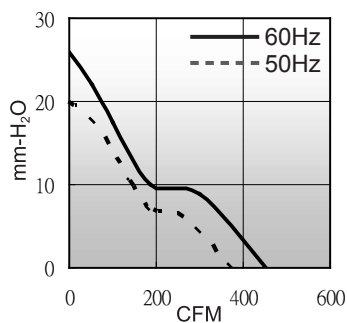

unit:mm